

PATIENT MEDICATION INFORMATION

READ THIS FOR SAFE AND EFFECTIVE USE OF YOUR MEDICINE

Pr**SOGROYA**[®]

Somapacitan injection

Read this carefully before you start taking **Sogroya**[®] and each time you get a refill. This leaflet is a summary and will not tell you everything about this drug. Talk to your healthcare professional about your medical condition and treatment and ask if there is any new information about **Sogroya**[®].

What is Sogroya[®] used for?

- Sogroya[®] is used for the long-term treatment of children and adolescents who are not growing because of low growth hormone levels.
- Sogroya[®] also replaces the growth hormone in adults with growth hormone deficiency.

How does Sogroya[®] work?

Sogroya[®] contains the active substance ‘somapacitan’.

- Somapacitan is a long-acting version of the natural growth hormone produced by the body with a single amino acid substitution.
- Somapacitan is made by ‘recombinant DNA technology’ meaning from cells that have received a gene (DNA) that makes them produce growth hormone. In Sogroya[®], a small side-chain has been attached to the growth hormone which links Sogroya[®] to the protein (albumin) naturally found in the blood to slow down its removal from the body allowing the medicines to be given less often.

What are the ingredients in Sogroya[®]?

Medicinal ingredients: somapacitan

Non-medicinal ingredients: histidine, hydrochloric acid (as needed), mannitol, phenol, poloxamer 188, sodium hydroxide (as needed) and water for injection

Sogroya[®] comes in the following dosage forms:

Sogroya[®] is available as a pre-filled disposable pen in 3 colour coded strengths:

- 5 mg / 1.5 mL pen with a teal pen cap and dose button
- 10 mg / 1.5 mL pen with a yellow pen cap and dose button
- 15 mg / 1.5 mL pen with a rubine red pen cap and dose button

Do not use Sogroya[®] if:

- If you are **allergic** to ‘somapacitan’ or ‘phenol’ or any of the other ingredients of Sogroya[®] (see **What are the ingredients in Sogroya[®]?**).
- If you have a **tumour** which is growing. You must have finished your anti-tumour treatment before you start your Sogroya[®] treatment. Sogroya[®] must be discontinued if the tumour grows.

- (Adults only) If you have had **open heart surgery** or **abdominal surgery**.
- (Adults only) If you have **serious accidental injury, severe breathing problems**.
- (Children only) If your bones have already finished growing (this is called closure of the growth plates).
- (Children only) If you have Prader-Willi syndrome and are severely obese or have breathing problems, including sleep apnea.

To help avoid side effects and ensure proper use, talk to your healthcare professional before you take Sogroya®. Talk about any health conditions or problems you may have, including if you:

- have ever had any kind of cancer or another kind of **tumour**.
- have **high blood sugar** (hyperglycemia) as your blood sugar may need to be checked regularly and the dose of your diabetes medicines may need to be adjusted.
- have a **replacement therapy with glucocorticoids**, because you have been told your body does not produce enough (adrenocortical insufficiency). You should consult your doctor regularly, as you may need adjustment of your glucocorticoid dose.
- have severe **headaches, eyesight problems, nausea, or vomiting** as these could be symptoms of increased pressure in the brain (benign intracranial hypertension) as your treatment may need to be stopped.
- have **thyroid problems**, your thyroid hormones need to be checked regularly and your dose of thyroid hormone may need to be adjusted.
- (Adults only) are a woman taking hormonal replacement therapy with estrogen, your dose of Sogroya® may need to be higher. If you stop using oral estrogen, your dose of Sogroya® may need to be reduced. Your doctor may recommend you to change to a vaginal hormone product or a hormone patch.
- are pregnant or plan to become pregnant. It is not known if Sogroya® will harm your unborn baby. Talk to your healthcare provider if you are pregnant or plan to become pregnant.
- are breastfeeding or plan to breastfeed. It is not known if Sogroya® passes into your breast milk. You and your healthcare provider should decide if you will take Sogroya® while you breastfeed.
- have **scoliosis**. Growth hormone treatment increases growth rate, and progression of pre-existing scoliosis can occur.
- (children only) **have hip or knee pain**, or begin to **limp** while on treatment.
- have changes in **skin** colour or in the appearance of birthmarks or **moles** on the skin.

Other warnings you should know about:

Thickening of skin

If you inject Sogroya® at the same site for a long period, thickened skin may appear where you inject your medicine. Change the place of injection on your body from one week to the next.

Antibodies

Antibodies against somapacitan may occur as it happens with other growth hormone treatments. If your healthcare professional suspects you have developed these antibodies, they may test you for antibodies against somapacitan.

Tell your healthcare professional about all the medicines you take, including any drugs, vitamins, minerals, natural supplements or alternative medicines.

The following may interact with Sogroya®:

- **Glucocorticoids** such as hydrocortisone, dexamethasone and prednisolone
- **Estrogen** as part of the oral hormonal replacement therapy
- **Male sex hormones** (androgen medicines) such as testosterone
- **Gonadotropin** medicines (gonad stimulating hormone) which stimulate the production of sex hormones
- **Insulin** or other diabetes medicines
- **Thyroid** hormone medicines such as thyroxine and levothyroxine
- **Anticonvulsants** medicines – such as carbamazepine and diazepam
- **Cyclosporine** (immunosuppressive) – a medicine to suppress your immune system

How to take Sogroya®:

Always use this medicine exactly as your healthcare professional has told you. Check with your healthcare professional if you are not sure.

Sogroya® is given as an injection under the skin (subcutaneous injection). Do not inject it into a vein or muscle. Before you use the pen for the first time, your doctor or nurse will show you how to use it.

The best places to give the injection are:

- the front of your thighs
- the front of your waist (abdomen)
- the buttocks
- the upper arms (children only)

Change the place on your body where you inject into every week.

For detailed instructions on how to inject Sogroya®, please see **Instructions for Use**.

When to use Sogroya®

- You should use Sogroya® once a week on the same day each week if possible.
- You can give yourself the injection at any time of the day.

If you are changing from another weekly growth hormone therapy to Sogroya®, you are advised to continue your usual once weekly dosing schedule.

If you are changing from daily growth hormone therapy to Sogroya® choose the preferred day for the weekly dose and stop final dose of daily treatment the day before (or at least 8 hours before) taking the first dose of Sogroya®.

Changing from another type or brand of growth hormone should be done by your healthcare professional.

On occasions when administration at the scheduled dosing day is not possible, you can take Sogroya[®] up to 2 days before or 3 days after your scheduled dosing day. The next dose you can take as usual the following week.

If necessary, you can change the day of your weekly injection of Sogroya[®] as long as it has been at least 4 days since your last injection of it. After selecting a new dosing day, continue with once a week dosing.

How long you will need treatment for

You may need Sogroya[®] for as long as your body does not produce enough growth hormone

- If you are taking Sogroya[®] for growth failure you will continue using Sogroya[®] until you stop growing.
- If you still lack growth hormone after you stop growing, you may need to continue using Sogroya[®] into adulthood.
- Do not stop using Sogroya[®] without discussing this with your healthcare professional first.

Usual dose:

Children and adolescents

The dose for children and adolescents depends on their body weight. The recommended dose of Sogroya[®] is 0.16 mg per kg body weight given once a week. Your child's dose may be lowered from the recommended dose according to blood test results, as necessary.

Adults

The usual starting dose is 1.5 mg once a week if you get growth hormone treatment for the first time and if you are already in treatment with daily growth hormone (somatropin medicine). If you are a woman taking oral estrogen (hormonal replacement therapy) you may need a higher dose of Sogroya[®]. If you are above 60 years, you may need a lower dose. See Table 1 below.

Table 1: Starting dose recommendation

Adult growth hormone deficiency	Recommended starting dose
You are between 18-60 years	1.5 mg/week
You are a woman on oral estrogen therapy regardless of age	2 mg/week
You are 60 years or above	1 mg/week

Your doctor may increase or decrease your dose step by step and regularly until you are on the right dose based on your individual needs and your experience of side effects.

- Do not take more than a maximum of 8 mg once a week.
- Do not change your dose unless your doctor has told you to.

After you have reached your right dose, your doctor will evaluate your treatment every 6 to 12 months. You may need to have your body mass index checked and blood samples taken.

If you have any further questions on the use of this medicine, ask your healthcare professional.

Overdose:

If you think you, or a person you are caring for, have taken too much Sogroya[®], contact a healthcare professional, hospital emergency department, or regional poison control centre immediately, even if there are no symptoms.

Missed Dose:

If you forget to inject a dose:

- and it is 3 days or less after you should have used Sogroya[®], use it as soon as you remember. Then inject your next dose as usual the following week.
- and it is more than 3 days since you should have used Sogroya[®], skip the missed dose. Then inject your next dose as usual on your next scheduled day.

Do not take an extra dose or increase the dose to make up for a missed dose.

What are possible side effects from using Sogroya[®]?

These are not all the possible side effects you may have when taking Sogroya[®]. If you experience any side effects not listed here, tell your healthcare professional.

Side effects seen in children and adolescents

Very common: may affect more than 1 in 10 people

- **Headache**

Common: may affect up to 1 in 10 people

- **Swollen hands and feet** due to **fluid retention**
- Decreased thyroid hormone (hypothyroidism)
- Redness and pain in the area of injection
- **Joint pain**
- **High blood sugar** (hyperglycemia)
- Feeling very tired (fatigue)
- The **adrenal glands do not make enough steroid hormones** (adrenocortical insufficiency)

Side effects seen in adults

Very common: may affect more than 1 in 10 people

- **Headache**

Common: may affect up to 1 in 10 people

- **Swollen hands and feet** due to **fluid retention**
- Decreased thyroid hormone (hypothyroidism)
- The **adrenal glands do not make enough steroid hormones** (adrenocortical insufficiency)
- Feeling very tired or weak (fatigue or asthenia)
- Redness and pain in the area of injection
- **High blood sugar** (hyperglycemia)
- **Joint pain**
- Feeling of '**pins and needles**' mainly in fingers

Uncommon: may affect up to 1 in 100 people

- **Thickening of skin** where you **inject** your medicine (lipohypertrophy)
- **Numb feeling and tingling in your hand(s)** (carpal tunnel syndrome)

Serious side effects and what to do about them			
Symptom / effect	Talk to your healthcare professional		Stop taking drug and get immediate medical help
	Only if severe	In all cases	
VERY COMMON			
Headache	✓		
COMMON			
Swollen hands and feet due to fluid retention	✓		
Decreased thyroid hormone (hypothyroidism)	✓		
Redness and pain in the area of injection	✓		
Joint pain	✓		
High blood sugar (hyperglycemia)	✓		
Feeling very tired or weak (fatigue or asthenia)	✓		
The adrenal glands do not make enough steroid hormones (adrenocortical insufficiency).	✓		
Feeling of 'pins and needles' mainly in fingers	✓		
RARE			
Thickening of skin where you inject your medicine (lipohypertrophy)	✓		
Numb feeling and tingling in your hand(s) (carpal tunnel syndrome)	✓		

If you have a troublesome symptom or side effect that is not listed here or becomes bad enough to interfere with your daily activities, tell your healthcare professional.

Reporting Side Effects

You can report any suspected side effects associated with the use of health products to Health Canada by:

- Visiting the Web page on Adverse Reaction Reporting (<https://www.canada.ca/en/health-canada/services/drugs-health-products/medeffect-canada.html>) for information on how to report online, by mail or by fax; or
- Calling toll-free at 1-866-234-2345.

NOTE: Contact your health professional if you need information about how to manage your side effects. The Canada Vigilance Program does not provide medical advice.

Storage:

Do not use this medicine after the expiry date which is stated on the pen label and carton after 'EXP'. The expiry date refers to the last day of that month.

Before opening*

- Store in refrigerator (2°C - 8°C).
- Do not freeze or expose to heat.
- Keep away from the cooling element inside the fridge.
- Do not use Sogroya® if it has been frozen.
- Keep unused (unopened) Sogroya® in the carton so that it stays clean and protected from light.
- If you are not able to store in a refrigerator before opening Sogroya®:
 - you can keep it at room temperature, 30°C and below for a maximum of 72 hours (3 days). This is as long as you keep Sogroya® as cool as possible and away from direct heat and light.
 - place Sogroya® in the refrigerator after this period of keeping it at room temperature.

During use*

- You can keep the pen for 6 weeks when stored in a refrigerator (2°C - 8°C).
- Keep away from the cooling element.
- Do not freeze.
- If you are not able to store the opened Sogroya® in a refrigerator:
 - it can be kept at room temperature, 30°C and below for a maximum of 72 hours (3 days). This is as long you keep it as cool as possible and away from direct heat and light.
 - return Sogroya® in the refrigerator after period of use at room temperature.

When you are not using the pen, keep the Sogroya® in the outer carton with pen cap on to protect from light.

Always remove the injection needle after each injection and store the pen without a needle attached.

***The total time allowed at room temperature, 30°C and below is 72 hours (3 days). This is regardless of whether the product is in-use (opened) or not in-use (unopened).**

Do not use this medicine if the solution does not appear clear to slightly opalescent, colourless to slightly yellow and free from visible particles. Do not throw away any medicines via wastewater or household waste. Ask your pharmacist how to throw away medicines you no longer use. These measures will help protect the environment.

Keep out of reach and sight of children.

If you want more information about Sogroya®:

- Talk to your healthcare professional
- Find the full product monograph that is prepared for healthcare professionals and includes this Patient Medication Information by visiting the Health Canada website: (<https://www.canada.ca/en/health-canada/services/drugs-health-products/drug-products/drug-product-database.html>); the manufacturer's website (<http://www.novonordisk.ca>), or by calling 1-800-465-4334.

This leaflet was prepared by Novo Nordisk Canada Inc.

Last Revised: 2023

Sogroya® is a registered trademark owned by Novo Nordisk Health Care AG and used under licence by Novo Nordisk Canada Inc.

NovoFine® is a registered trademark owned by Novo Nordisk A/S and used under licence by Novo Nordisk Canada Inc.

© 2023

Novo Nordisk Canada Inc.

Instructions for Use

Overview of Sogroya[®] pen

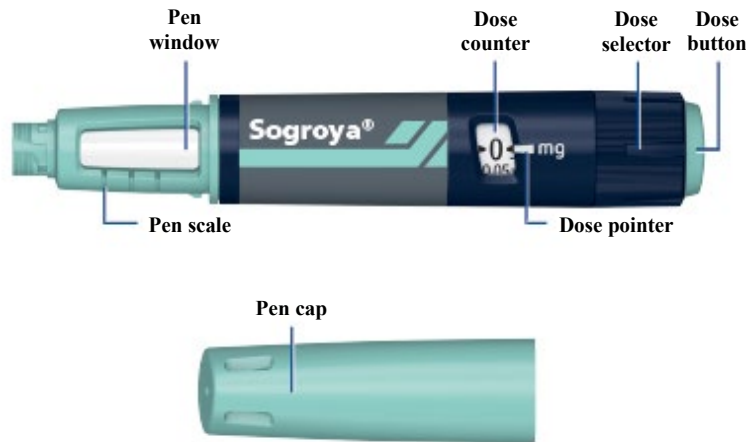

Needle (example)

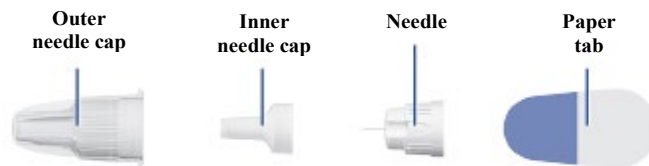

How to use your once weekly Sogroya[®] pen

5 steps you should follow for a Sogroya[®] injection:

Step 1. Prepare your Sogroya[®] pen

Step 2. Check the flow with each new pen

Step 3. Select your dose

Step 4. Inject your dose

Step 5. After your injection

For further information about your pen: see sections *Frequently Asked Questions, Important information, Patient Information*

Please read these instructions carefully before using your Sogroya[®] prefilled pen.



Pay special attention to these notes as they are important for safe use of the pen.



Additional information

Sogroya® is a prefilled growth hormone pen. It contains 5 mg of Sogroya® and delivers doses from 0.025 mg to 2 mg, in increments of 0.025 mg. Sogroya® is for use under the skin only (subcutaneous). Sogroya® prefilled pen is designed to be used with NovoFine® disposable needles up to a length of 8 mm.

Do not share your Sogroya® pen and needles with another person. You may give another person an infection or get an infection from them.

Do not use your pen without proper training from your doctor or nurse. Make sure that you are confident in making an injection with the pen before you start your treatment. If you are blind or have poor eyesight and cannot read the dose counter on the pen, do not use this pen without help. Get help from a person with good eyesight who is trained to use the pen.

Step 1. Prepare your once weekly Sogroya® pen

- Wash your hands with soap and water.
- **Check the name, strength, and coloured label** on your pen to make sure that it contains Sogroya® in the right strength.
- Pull off the pen cap.
- Turn the pen upside down once or twice to check that the Sogroya® in your pen is clear and colourless. See figure A. **If the Sogroya® looks cloudy, do not use the pen.**

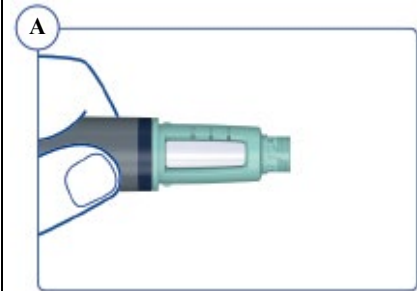

 Make sure the right pen is used. Especially if you use more than one type of injectable medicine. Using the wrong medicine could be harmful to your health.

- When you are ready to take your injection
- Firstly, take a new disposable needle and tear off the paper tab.
 - Then push the needle straight onto the pen. Turn the needle clockwise **until it is on tight**. See figure B.

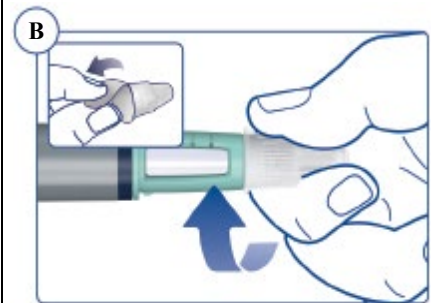

- Pull off the outer needle cap and keep it for later. You will need it after the injection, to safely remove the needle from the pen. See figure C.

 The needle is covered by two caps. You must remove both caps. If you forget to remove both caps you will not inject any medicine.

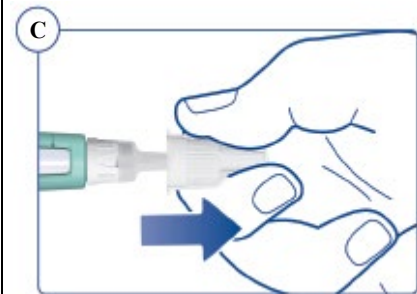

- Pull off the inner needle cap and dispose of it. If you try to put it back on, you may accidentally stick yourself with the needle. See figure D.

i A drop of Sogroya® may appear at the needle tip. This is normal, but you must still check the flow with each new pen. See step 2.

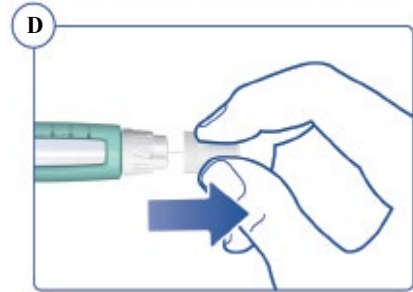

! **Always use a new needle for each injection.** This reduces the risk of contamination, infection, leakage of Sogroya®, and blocked needles leading to incorrect dosing.

! Never use a bent or damaged needle.

Step 2. Check the flow with each new pen

i If your pen is already in use, proceed to step 3.

- **Before using a new pen,** check the flow to make sure Sogroya® can flow through the pen and needle.
- Turn the dose selector clockwise one tick mark to select 0.025 mg. You may hear a faint click. See figure E.



- **One tick mark equals 0.025 mg** in the dose counter. See figure F.



- Hold the pen with the needle pointing up. Press and hold in the dose button until the dose counter returns to "0". **The "0" must line up with the dose pointer.** See figure G.



- Check that a drop of Sogroya[®] appears at the needle tip. See figure H.

(i)

If no Sogroya[®] appears, repeat step 2 up to 6 times.

If you still do not see a drop of Sogroya[®], **change the needle**. Remove the needle as described in step 5 and repeat step 1 and 2 again.

Do not use the pen if a drop of Sogroya[®] still does not appear after repeating step 2.

H



Step 3. Select your dose

- To start, check that the dose counter is set at "0".
- Turn the dose selector clockwise to select the dose you need. See figure I.

When you have selected your dose, you can proceed to step 4.

(i)

If there is not enough Sogroya[®] left to select a full dose, see *Frequently Asked Questions*.

I



(i)

The dose counter shows the dose in mg. See figures J and K. Always use the dose pointer to select the exact dose. **Do not count the pen clicks. Do not use the pen scale.**

J

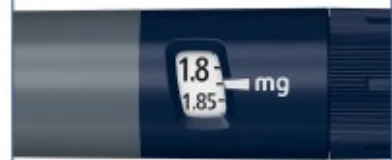

Example: 1.825 mg selected

K



Example: 1.85 mg selected

i If you select the wrong dose, you can turn the dose selector clockwise or counterclockwise to the correct dose. See figure L.

The pen clicks sound and feel differently when the dose selector is turned clockwise, counterclockwise, or if you accidentally force it past the number of mg left.



Step 4. Inject your dose

- Insert the needle into your skin as your doctor or nurse has shown you. See figure M.

Make sure you can see the dose counter. **Do not cover it with your fingers.** This could block the injection.

i Remember to change the injection site every week.

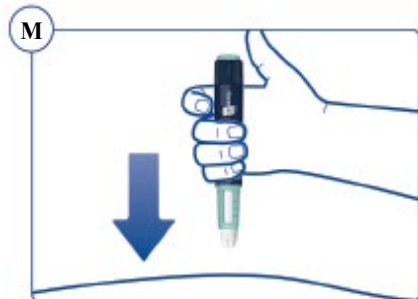

- Press and hold down the dose button until the dose counter shows "0". Keep pressing the dose button with the needle in your skin and slowly count to 6. See figure N and O. The "0" must line up with the dose pointer. You may then hear or feel a click.

i If "0" does not appear in the dose counter after continuously pressing the dose button, your needle or pen may be blocked or damaged, see *Frequently Asked Questions*.



Count slowly:



- Carefully remove the needle from your skin. See figure P. If blood appears at the injection site, press lightly. Do not rub the area.

i You may see a drop of Sogroya® at the needle tip after injecting. This is normal and does not affect your dose.

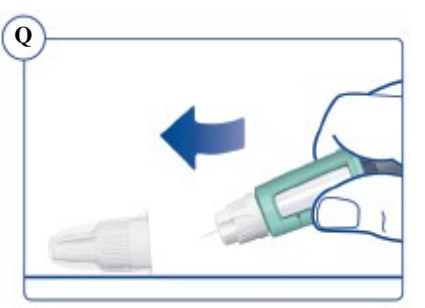
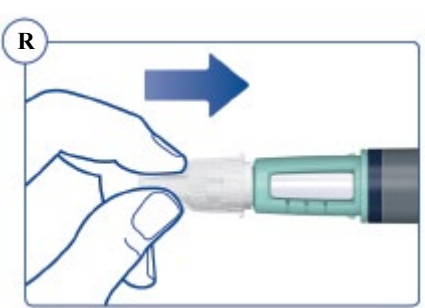
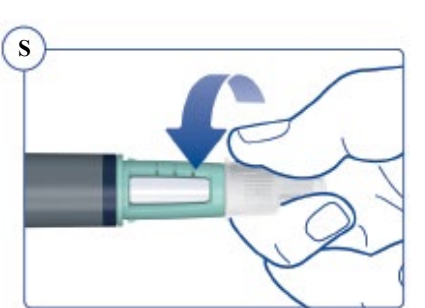
	
Step 5. After your injection	
<ul style="list-style-type: none"> • Insert the needle tip into the outer needle cap on a flat surface without touching the needle or the outer needle cap. See figure Q. 	
<ul style="list-style-type: none"> • Once the needle is covered, carefully push the outer needle cap completely on. See figure R. 	
<ul style="list-style-type: none"> • Unscrew the needle and dispose of it carefully as instructed by your doctor, nurse, pharmacist or local authorities. <p>Always dispose of the needle after each injection. When the pen is empty, throw it away without a needle on as instructed by your doctor, nurse, pharmacist or local authorities.</p> <p>The pen cap and the empty carton can be disposed of in your household trash.</p>	
<ul style="list-style-type: none"> • Put the pen cap on your pen after each use to protect Sogroya® from direct light. See figure T. <p>To store your pen, see 'Storage' in the <i>Patient Medication Information</i>.</p>	

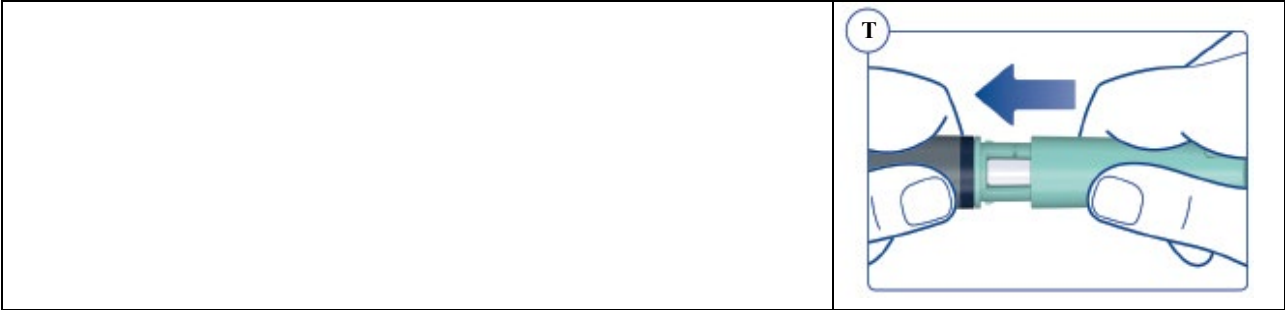

⚠ Do not try to put the inner needle cap back on.
You may stick yourself with the needle.

⚠ Always remove the needle from your pen immediately after each injection. This reduces the risk of contamination, infection, leakage of Sogroya®, and blocked needles leading to incorrect dosing.

Frequently Asked Questions

How do I see how much Sogroya® is left in my pen?

The pen scale shows you approximately how much Sogroya® is left in your pen. See figure U.

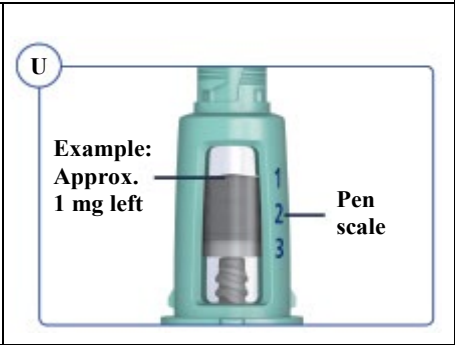

To see how much Sogroya® is left, use the dose counter: Turn the dose selector clockwise until the dose counter stops. You can select a maximum dose of 2 mg. If it shows “2”, at least 2 mg are left in your pen. If the dose counter stops at “1.2”, only 1.2 mg are left in your pen. See figure V.

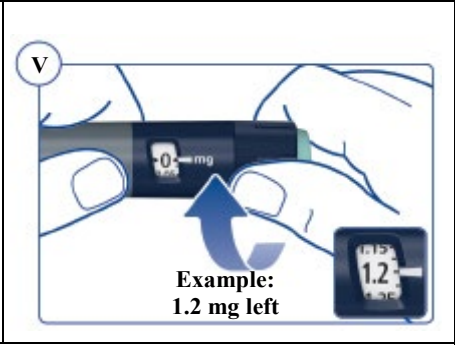

What if I need a larger dose than what is left in my pen?

It is not possible to select a larger dose than the amount of mg left in your pen.

If you need more Sogroya® than you have left in your pen, you can use a new pen or split your dose between your current pen and a new pen.

Only if trained or advised by your doctor or nurse, may you split your dose. Use a calculator to plan the doses as instructed by your doctor or nurse.

Be very careful to calculate correctly, otherwise it may lead to medication error. If you are not sure how to split your dose using two pens, then select and inject the dose you need with a new pen.

<p>What if no Sogroya[®] appears when I check the flow?</p>	<p>A. Your needle may be blocked or damaged, if no Sogroya[®] appears at the needle tip. Remove the needle as described in step 5 and repeat steps 1 and 2.</p> <p>B. Your pen may be defective, if Sogroya[®] still does not appear after changing the needle. Do not use the pen.</p>
<p>What if “0” does not appear after completing my injection?</p>	<p>In this case the needle or pen may be blocked or damaged, and you have not received any Sogroya[®] – even though the dose counter has moved from the original dose that you have set.</p> <p>Remove the needle as described in step 5 and repeat steps 1 to 4.</p>
<p>How should I take care of my pen?</p>	<p>Be careful not to drop your pen or knock it against hard surfaces. Do not expose your pen to dust, dirt, liquid, or direct light.</p> <p>If there is Sogroya[®] left in the pen, store the pen as directed in ‘Storage’ in the <i>Patient Medication Information</i>.</p> <p>Do not try to refill your pen, it is prefilled and must be disposed of when empty.</p>
<p>What if I drop my pen?</p>	<p>If you drop your pen or think that something is wrong with it, attach a new disposable needle and check the flow before you inject, see steps 1 and 2. If your pen has been dropped, check the cartridge, if the cartridge is cracked, do not use the pen. Do not try to repair your pen or pull it apart.</p>
<p>How do I clean my pen?</p>	<p>Do not wash, soak, or lubricate your pen. It may be cleaned with a mild detergent on a moistened cloth.</p>
<p> Important information</p> <ul style="list-style-type: none"> • Caregivers must be very careful when handling needles – to reduce the risk of needle sticks and cross-infection. • Always keep your pen and needles out of reach of others, especially children. • Do not use the pen if it is damaged. Do not try to repair your pen or pull it apart. • To store your pen, see ‘Storage’ in the <i>Patient Medication Information</i>. 	

Instructions for Use

Overview Sogroya[®] pen

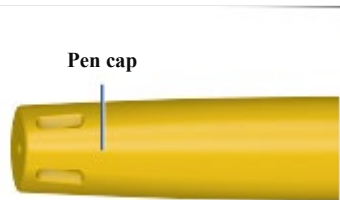

Needle (example)

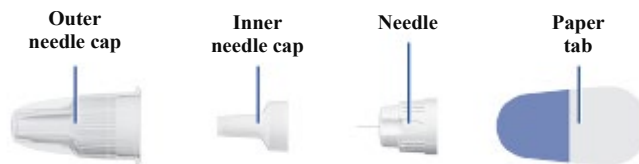

How to use your once weekly Sogroya[®] pen

5 steps you should follow for a Sogroya[®] injection:

- Step 1. Prepare your Sogroya[®] pen
- Step 2. Check the flow with each new pen
- Step 3. Select your dose
- Step 4. Inject your dose
- Step 5. After your injection

For further information about your pen: see sections *Frequently Asked Questions, Important information, Patient Information*

Please read these instructions carefully before using your Sogroya[®] prefilled pen.



Pay special attention to these notes as they are important for safe use of the pen.



Additional information

Sogroya[®] is a prefilled growth hormone pen. It contains 10 mg of Sogroya[®] and delivers doses from 0.05 mg to 4 mg, in increments of 0.05 mg. Sogroya[®] is for use under the skin only (subcutaneous). Sogroya[®] prefilled pen is designed to be used with NovoFine[®] disposable needles up to a length of 8 mm.

Do not share your Sogroya[®] pen and needles with another person. You may give another person an infection or get an infection from them.

Do not use your pen without proper training from your doctor or nurse. Make sure that you are confident in making an injection with the pen before you start your treatment. If you are blind or have poor eyesight and cannot read the dose counter on the pen, do not use this pen without help. Get help from a person with good eyesight who is trained to use the pen.

Step 1. Prepare your once weekly Sogroya[®] pen

- Wash your hands with soap and water.
- **Check the name, strength, and coloured label** on your pen to make sure that it contains Sogroya[®] in the right strength.
- Pull off the pen cap.
- Turn the pen upside down once or twice to check that the Sogroya[®] in your pen is clear and colourless. See figure A. **If the Sogroya[®] looks cloudy, do not use the pen.**

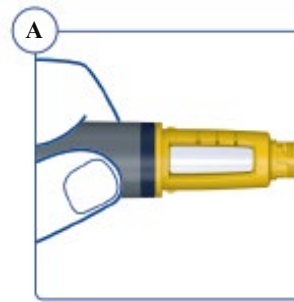

Make sure the right pen is used. Especially if you use more than one type of injectable medicine. Using the wrong medicine could be harmful to your health.

When you are ready to take your injection

- Firstly, take a new disposable needle and tear off the paper tab.
- Then push the needle straight onto the pen. Turn the needle clockwise **until it is on tight.** See figure B.

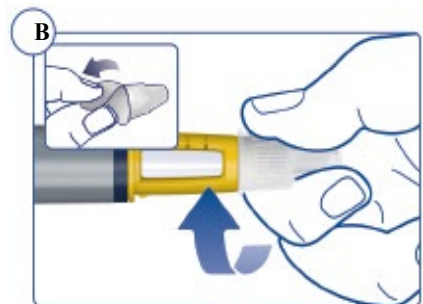

- Pull off the outer needle cap and keep it for later. You will need it after the injection, to safely remove the needle from the pen. See figure C.

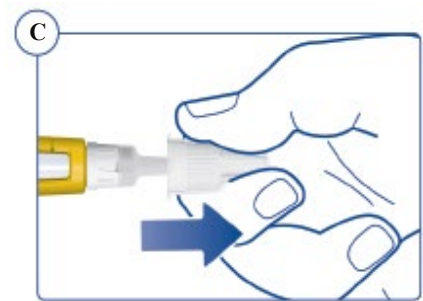

The needle is covered by two caps. You must remove both caps. If you forget to remove both caps you will not inject any medicine.

- Pull off the inner needle cap and dispose of it. If you try to put it back on, you may accidentally stick yourself with the needle. See figure D.

i A drop of Sogroya® may appear at the needle tip. This is normal, but you must still check the flow with each new pen. See step 2.

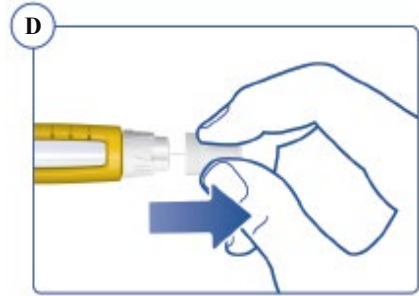

! **Always use a new needle for each injection.** This reduces the risk of contamination, infection, leakage of Sogroya®, and blocked needles leading to incorrect dosing.

! Never use a bent or damaged needle.

Step 2. Check the flow with each new pen

i If your pen is already in use, proceed to step 3.

- **Before using a new pen,** check the flow to make sure Sogroya® can flow through the pen and needle.
- Turn the dose selector clockwise one tick mark to select 0.05 mg. You may hear a faint click. See figure E.



- **One tick mark equals 0.05 mg** in the dose counter. See figure F.

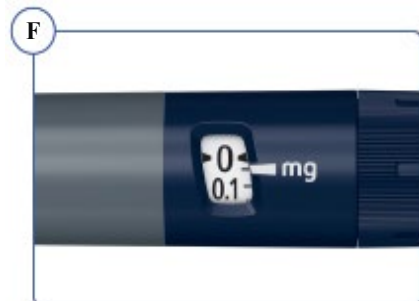

- Hold the pen with the needle pointing up. Press and hold in the dose button until the dose counter returns to "0". **The "0" must line up with the dose pointer.** See figure G.



- Check that a drop of Sogroya[®] appears at the needle tip. See figure H.

i If no Sogroya[®] appears, repeat step 2 up to 6 times.

If you still do not see a drop of Sogroya[®], **change the needle**. Remove the needle as described in step 5 and repeat step 1 and 2 again.

Do not use the pen if a drop of Sogroya[®] still does not appear after repeating step 2.

H



Step 3. Select your dose

- To start, check that the dose counter is set at "0".
- Turn the dose selector clockwise to select the dose you need. See figure I.

When you have selected your dose, you can proceed to step 4.

i If there is not enough Sogroya[®] left to select a full dose, see *Frequently Asked Questions*.

I



i The dose counter shows the dose in mg. See figures J and K. Always use the dose pointer to select the exact dose. **Do not count the pen clicks. Do not use the pen scale.**

J

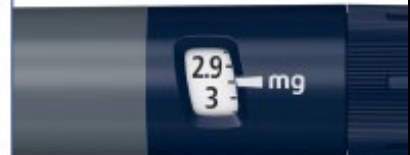

Example: 2.95 mg selected

K

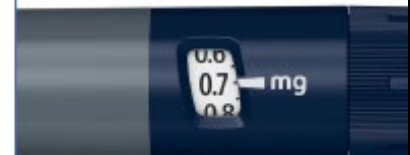

Example: 0.7 mg selected

i If you select the wrong dose, you can turn the dose selector clockwise or counterclockwise to the correct dose. See figure L.

The pen clicks sound and feel differently when the dose selector is turned clockwise, counterclockwise, or if you accidentally force it past the number of mg left.

L



Step 4. Inject your dose

- Insert the needle into your skin as your doctor or nurse has shown you. See figure M.

Make sure you can see the dose counter. **Do not cover it with your fingers.** This could block the injection.

 **Remember to change the injection site every week.**

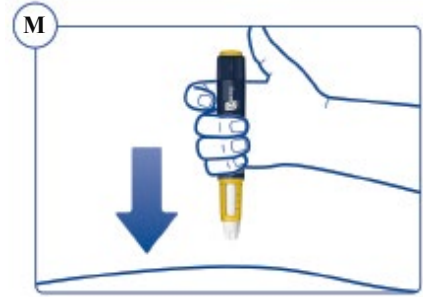

- **Press and hold down the dose button until the dose counter shows “0”.** Keep pressing the dose button with the needle in your skin and slowly count to 6. See figure N and O. The “0” must line up with the dose pointer. You may then hear or feel a click.

 If “0” does not appear in the dose counter after continuously pressing the dose button, your needle or pen may be blocked or damaged, see *Frequently Asked Questions*.

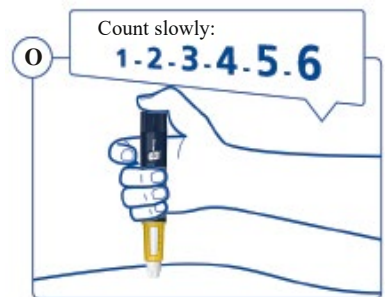
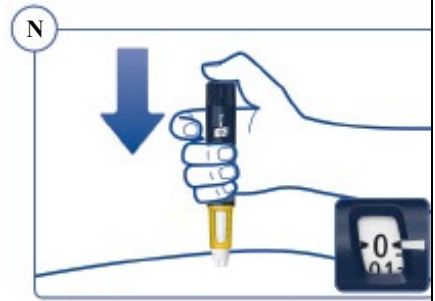

- Carefully remove the needle from your skin. See figure P. If blood appears at the injection site, press lightly. Do not rub the area.

 You may see a drop of Sogroya® at the needle tip after injecting. This is normal and does not affect your dose.

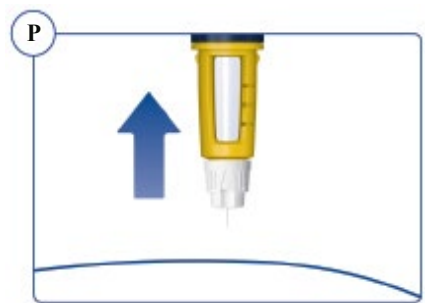

Step 5. After your injection

- Insert the needle tip into the outer needle cap on a flat surface without touching the needle or the outer needle cap. See figure Q.

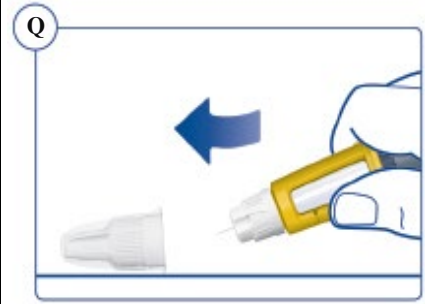

- Once the needle is covered, carefully push the outer needle cap completely on. See figure R.

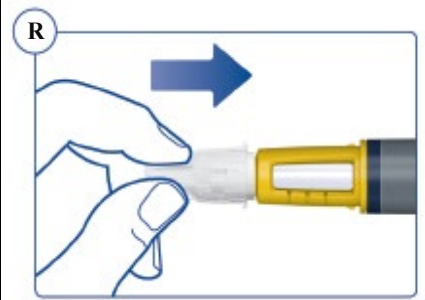

- Unscrew the needle and dispose of it carefully as instructed by your doctor, nurse, pharmacist or local authorities.
Always dispose of the needle after each injection.
When the pen is empty, throw it away **without** a needle on as instructed by your doctor, nurse, pharmacist or local authorities.

The pen cap and the empty carton can be disposed of in your household trash.

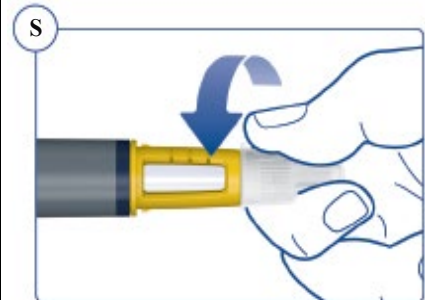

- Put the pen cap on your pen after each use to protect Sogroya® from direct light. See figure T.

To store your pen, see 'Storage' in the *Patient Medication Information*.

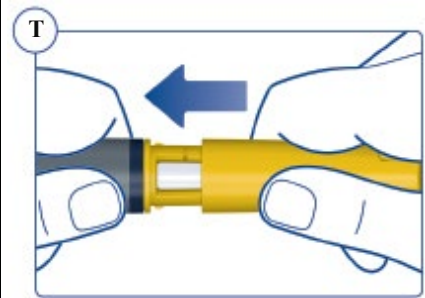

 **Do not try to put the inner needle cap back on.**
You may stick yourself with the needle.

 Always remove the needle from your pen immediately after each injection. This reduces the risk of contamination, infection, leakage of Sogroya®, and blocked needles leading to incorrect dosing.

Frequently Asked Questions

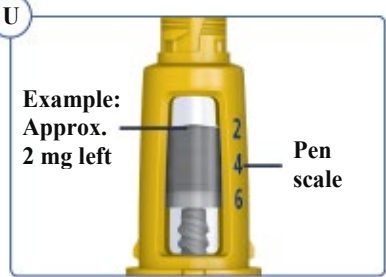
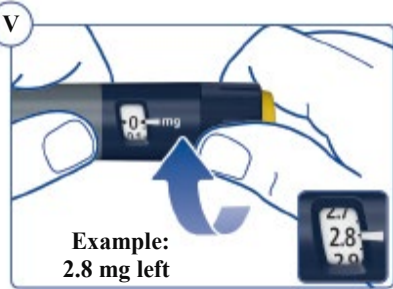
<p>How do I see how much Sogroya® is left in my pen?</p> <p>The pen scale shows you approximately how much Sogroya® is left in your pen. See figure U.</p>	
<p>To see how much Sogroya® is left, use the dose counter: Turn the dose selector clockwise until the dose counter stops. You can select a maximum dose of 4 mg. If it shows “4”, at least 4 mg are left in your pen. If the dose counter stops at “2.8”, only 2.8 mg are left in your pen. See figure V.</p>	
<p>What if I need a larger dose than what is left in my pen?</p>	<p>It is not possible to select a larger dose than the amount of mg left in your pen.</p> <p>If you need more Sogroya® than you have left in your pen, you can use a new pen or split your dose between your current pen and a new pen.</p> <p>Only if trained or advised by your doctor or nurse, may you split your dose. Use a calculator to plan the doses as instructed by your doctor or nurse.</p> <p>Be very careful to calculate correctly, otherwise it may lead to medication error. If you are not sure how to split your dose using two pens, then select and inject the dose you need with a new pen.</p>
<p>What if no Sogroya® appears when I check the flow?</p>	<p>A. Your needle may be blocked or damaged, if no Sogroya® appears at the needle tip. Remove the needle as described in step 5 and repeat steps 1 and 2.</p> <p>B. Your pen may be defective, if Sogroya® still does not appear after changing the needle. Do not use the pen.</p>
<p>What if “0” does not appear after completing my injection?</p>	<p>In this case the needle or pen may be blocked or damaged, and you have not received any Sogroya® – even though the dose counter has moved from the original dose that you have set. Remove the needle as described in step 5 and repeat steps 1 to 4.</p>
<p>How should I take care of my pen?</p>	<p>Be careful not to drop your pen or knock it against hard surfaces. Do not expose your pen to dust, dirt, liquid, or direct light.</p> <p>If there is Sogroya® left in the pen, store the pen as directed in ‘Storage’ in the <i>Patient Medication Information</i>.</p> <p>Do not try to refill your pen, it is prefilled and must be disposed of when empty.</p>

What if I drop my pen?	If you drop your pen or think that something is wrong with it, attach a new disposable needle and check the flow before you inject, see steps 1 and 2. If your pen has been dropped, check the cartridge, if the cartridge is cracked, do not use the pen. Do not try to repair your pen or pull it apart.
How do I clean my pen?	Do not wash, soak, or lubricate your pen. It may be cleaned with a mild detergent on a moistened cloth.
 <p>Important information</p> <ul style="list-style-type: none"> • Caregivers must be very careful when handling needles – to reduce the risk of needle sticks and cross-infection. • Always keep your pen and needles out of reach of others, especially children. • Do not use the pen if it is damaged. Do not try to repair your pen or pull it apart. • To store your pen, <i>see 'Storage' in the Patient Medication Information.</i> 	

Instructions For Use

Overview Sogroya[®] pen

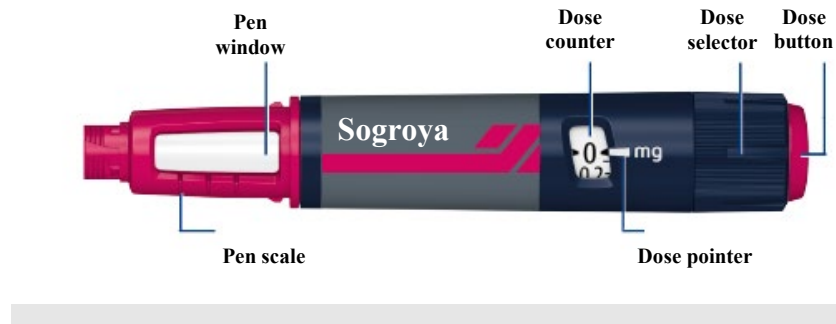

Pen cap



Needle (example)

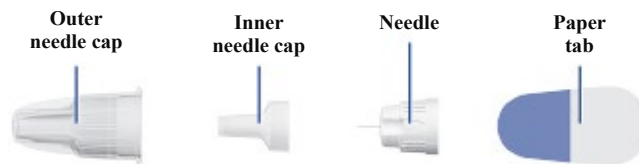

How to use your once weekly Sogroya[®] pen

5 steps you should follow for a Sogroya[®] injection:

- Step 1. Prepare your Sogroya[®] pen
- Step 2. Check the flow with each new pen
- Step 3. Select your dose
- Step 4. Inject your dose
- Step 5. After your injection

For further information about your pen: see sections *Frequently Asked Questions*, *Important information*, *Patient Information*

Please read these instructions carefully before using your Sogroya[®] prefilled pen.

 Pay special attention to these notes as they are important for safe use of the pen.

 Additional information

Sogroya[®] is a prefilled growth hormone pen. It contains 15 mg of Sogroya[®] and delivers doses from 0.1 mg to 8 mg, in increments of 0.1 mg. Sogroya[®] is for use under the skin only (subcutaneous). Sogroya[®] prefilled pen is designed to be used with NovoFine[®] disposable needles up to a length of 8 mm.

Do not share your Sogroya[®] pen and needles with another person. You may give another person an infection or get an infection from them.

Do not use your pen without proper training from your doctor or nurse. Make sure that you are confident in making an injection with the pen before you start your treatment. If you are blind or have poor eyesight and cannot read the dose counter on the pen, do not use this pen without help. Get help from a person with good eyesight who is trained to use the pen.

Step 1. Prepare your once weekly Sogroya[®] pen

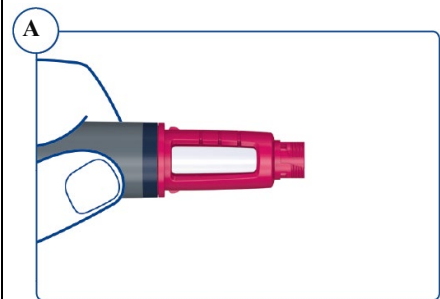

- Wash your hands with soap and water.
- **Check the name, strength, and coloured label** on your pen to make sure that it contains Sogroya[®] in the right strength.
- Pull off the pen cap.
- Turn the pen upside down once or twice to check that the Sogroya[®] in your pen is clear and colourless. See figure A. **If the Sogroya[®] looks cloudy, do not use the pen.**

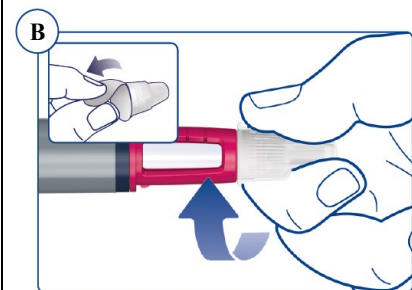

 Make sure the right pen is used. Especially if you use more than one type of injectable medicine. Using the wrong medicine could be harmful to your health.

- When you are ready to take your injection
- Firstly, take a new disposable needle and tear off the paper tab.
 - Then push the needle straight onto the pen. Turn the needle clockwise **until it is on tight**. See figure B.

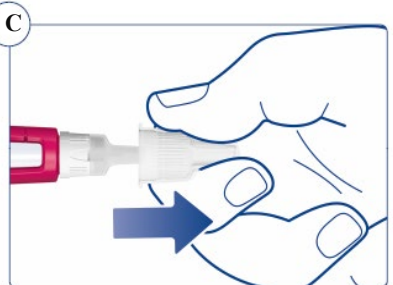

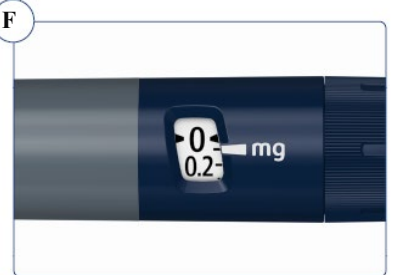
<ul style="list-style-type: none"> • Pull off the outer needle cap and keep it for later. You will need it after the injection, to safely remove the needle from the pen. See figure C. <p>i The needle is covered by two caps. You must remove both caps. If you forget to remove both caps you will not inject any medicine.</p>	
<ul style="list-style-type: none"> • Pull off the inner needle cap and dispose of it. If you try to put it back on, you may accidentally stick yourself with the needle. See figure D. <p>i A drop of Sogroya® may appear at the needle tip. This is normal, but you must still check the flow with each new pen. See step 2.</p>	
<p>! Always use a new needle for each injection. This reduces the risk of contamination, infection, leakage of Sogroya®, and blocked needles leading to incorrect dosing.</p> <p>! Never use a bent or damaged needle.</p>	
<p>Step 2. Check the flow with each new pen</p>	
<p>i If your pen is already in use, proceed to step 3.</p> <ul style="list-style-type: none"> • Before using a new pen, check the flow to make sure Sogroya® can flow through the pen and needle. • Turn the dose selector clockwise one tick mark to select 0.1 mg. You may hear a faint click. See figure E. 	
<ul style="list-style-type: none"> • One tick mark equals 0.1 mg in the dose counter. See figure F. 	

- Hold the pen with the needle pointing up. Press and hold in the dose button until the dose counter returns to “0”. **The “0” must line up with the dose pointer.** See figure G.



- Check that a drop of Sogroya® appears at the needle tip. See figure H.

i If no Sogroya® appears, repeat step 2 up to 6 times.

If you still do not see a drop of Sogroya®, **change the needle.** Remove the needle as described in step 5 and repeat step 1 and 2 again.

Do not use the pen if a drop of Sogroya® still does not appear after repeating step 2.



Step 3. Select your dose

- To start, check that the dose counter is set at “0”.
- Turn the dose selector clockwise to select the dose you need. See figure I.



When you have selected your dose, you can proceed to step 4.

i If there is not enough Sogroya® left to select a full dose, see *Frequently Asked Questions*.



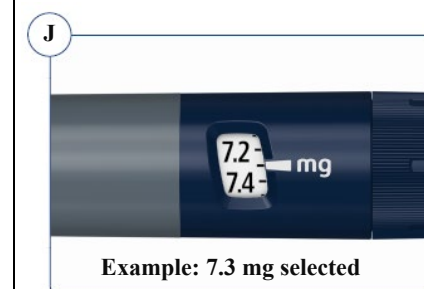

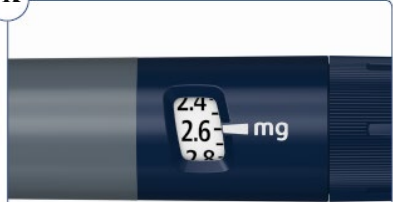
i The dose counter shows the dose in mg. See figures J and K. Always use the dose pointer to select the exact dose. **Do not count the pen clicks. Do not use the pen scale.**



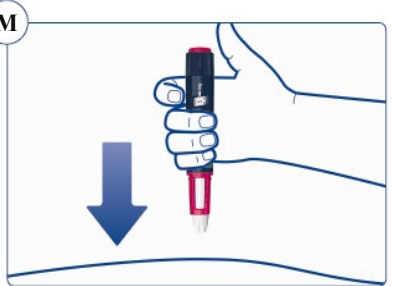

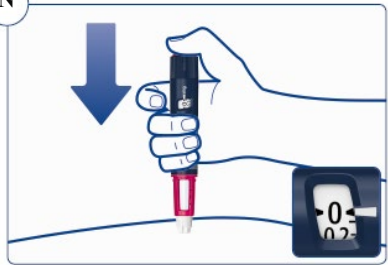
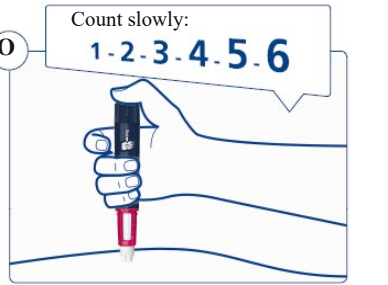

	<p>K</p>  <p>Example: 2.6 mg selected</p>
<p>i If you select the wrong dose, you can turn the dose selector clockwise or counterclockwise to the correct dose. See figure L.</p> <p>The pen clicks sound and feel differently when the dose selector is turned clockwise, counterclockwise, or if you accidentally force it past the number of mg left.</p>	<p>L</p> 

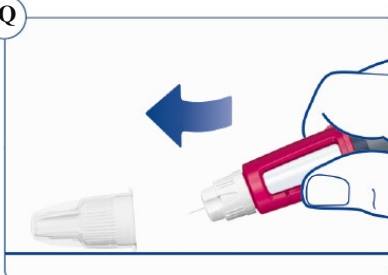
<p>Step 4. Inject your dose</p>	
<ul style="list-style-type: none"> • Insert the needle into your skin as your doctor or nurse has shown you. See figure M. <p>Make sure you can see the dose counter. Do not cover it with your fingers. This could block the injection.</p> <p>i Remember to change the injection site every week.</p>	<p>M</p> 
<ul style="list-style-type: none"> • Press and hold down the dose button until the dose counter shows “0”. Keep pressing the dose button with the needle in your skin and slowly count to 6. See figure N and O. <p>The “0” must line up with the dose pointer. You may then hear or feel a click.</p> <p>i If “0” does not appear in the dose counter after continuously pressing the dose button, your needle or pen may be blocked or damaged, see <i>Frequently Asked Questions</i>.</p>	

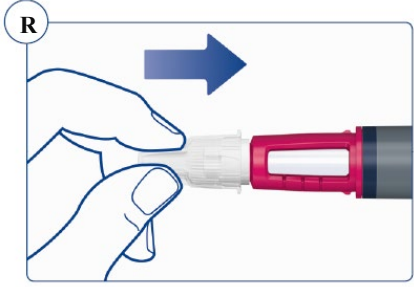
	<p>N</p>  <p>O</p> <p>Count slowly: 1-2-3-4-5-6</p> 
<ul style="list-style-type: none"> Carefully remove the needle from your skin. See figure P. If blood appears at the injection site, press lightly. Do not rub the area. <p>i You may see a drop of Sogroya® at the needle tip after injecting. This is normal and does not affect your dose.</p>	<p>P</p> 

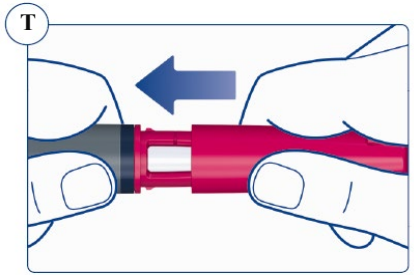
Step 5. After your injection	
<ul style="list-style-type: none"> Insert the needle tip into the outer needle cap on a flat surface without touching the needle or the outer needle cap. See figure Q. 	<p>Q</p> 
<ul style="list-style-type: none"> Once the needle is covered, carefully push the outer needle cap completely on. See figure R. 	

	
<ul style="list-style-type: none"> • Unscrew the needle and dispose of it carefully as instructed by your doctor, nurse, pharmacist or local authorities. <p>Always dispose of the needle after each injection. When the pen is empty, throw it away without a needle on as instructed by your doctor, nurse, pharmacist or local authorities.</p> <p>The pen cap and the empty carton can be disposed of in your household trash.</p>	
<ul style="list-style-type: none"> • Put the pen cap on your pen after each use to protect Sogroya® from direct light. See figure T. <p>To store your pen, see 'Storage' in the <i>Patient Medication Information</i>.</p>	
<p> Do not try to put the inner needle cap back on. You may stick yourself with the needle.</p> <p> Always remove the needle from your pen immediately after each injection. This reduces the risk of contamination, infection, leakage of Sogroya®, and blocked needles leading to incorrect dosing.</p>	

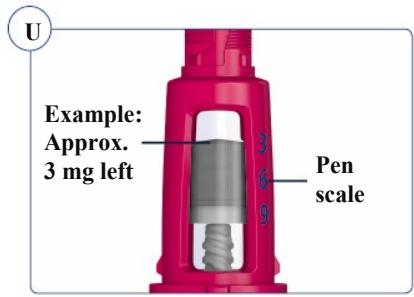
<p>Frequently Asked Questions</p>	
<p>How do I see how much Sogroya® is left in my pen?</p> <p>The pen scale shows you approximately how much Sogroya® is left in your pen. See figure U.</p>	

To see how much Sogroya[®] is left, use the dose counter: Turn the dose selector clockwise until the dose counter stops. You can select a maximum dose of 8 mg. If it shows “8”, at least 8 mg are left in your pen. If the dose counter stops at “4.8”, only 4.8 mg are left in your pen. See figure V.

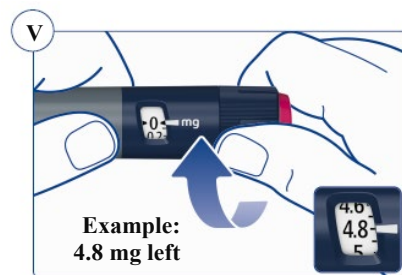

What if I need a larger dose than what is left in my pen?

It is not possible to select a larger dose than the amount of mg left in your pen. If you need more Sogroya[®] than you have left in your pen, you can use a new pen or split your dose between your current pen and a new pen. **Only if trained or advised by your doctor or nurse, may you split your dose.** Use a calculator to plan the doses as instructed by your doctor or nurse.

Be very careful to calculate correctly, otherwise it may lead to medication error. If you are not sure how to split your dose using two pens, then select and inject the dose you need with a new pen.

What if no Sogroya[®] appears when I check the flow?

A. Your needle may be blocked or damaged, if no Sogroya[®] appears at the needle tip. Remove the needle as described in step 5 and repeat steps 1 and 2.

B. Your pen may be defective, if Sogroya[®] still does not appear after changing the needle. Do not use the pen.

What if “0” does not appear after completing my injection?

In this case the needle or pen may be blocked or damaged, and **you have not received any Sogroya[®]** – even though the dose counter has moved from the original dose that you have set. Remove the needle as described in step 5 and repeat steps 1 to 4.

How should I take care of my pen?

Be careful not to drop your pen or knock it against hard surfaces. Do not expose your pen to dust, dirt, liquid, or direct light. If there is Sogroya[®] left in the pen, store the pen as directed in ‘Storage’ in the *Patient Medication Information*. Do not try to refill your pen, it is prefilled and must be disposed of when empty.

What if I drop my pen?

If you drop your pen or think that something is wrong with it, attach a new disposable needle and check the flow before you inject, see steps 1 and 2. If your pen has been dropped, check the cartridge, if the cartridge is cracked, do not use the pen. Do not try to repair your pen or pull it apart.

How do I clean my pen?

Do not wash, soak, or lubricate your pen. It may be cleaned with a mild detergent on a moistened cloth.



Important information

- Caregivers must be very careful when handling needles – to reduce the risk of needle sticks and cross-infection.
- Always keep your pen and needles out of reach of others, especially children.
- **Do not use the pen** if it is damaged. Do not try to repair your pen or pull it apart.
- To store your pen, see '*Storage*' in the *Patient Medication Information*.